



Beam Lead Schottky Diode Pairs for Mixers and Detectors

Technical Data

HSCH-5500 Series

Features

- **Monolithic Pair**
Closely Matched Electrical Parameters
- **Low Capacitance**
0.1 pF Maximum at 0 Volts
- **Low Noise Figure**
Typical 7.5 dB at 26 GHz
- **Rugged Construction**
4 Grams Minimum Lead Pull
- **Platinum Tri-Metal System**
High Temperature Stability
- **Polyimide Scratch Protection**
- **Silicon Nitride Passivation**
Stable, Reliable Performance

Description

These dual beam lead diodes are constructed using a metal-semiconductor Schottky barrier junction. Advanced epitaxial techniques and precise process control insure uniformity and repeatability of this planar passivated microwave semiconductor. A nitride passivation layer provides immunity from contaminants which could otherwise lead to I_R drift.

The Agilent beam lead process allows for large beam anchor pads for rugged construction (typical 6 gram pull strength) without degrading capacitance.

Outline 04B

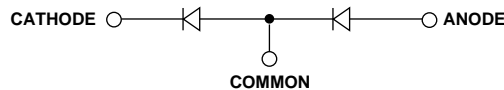
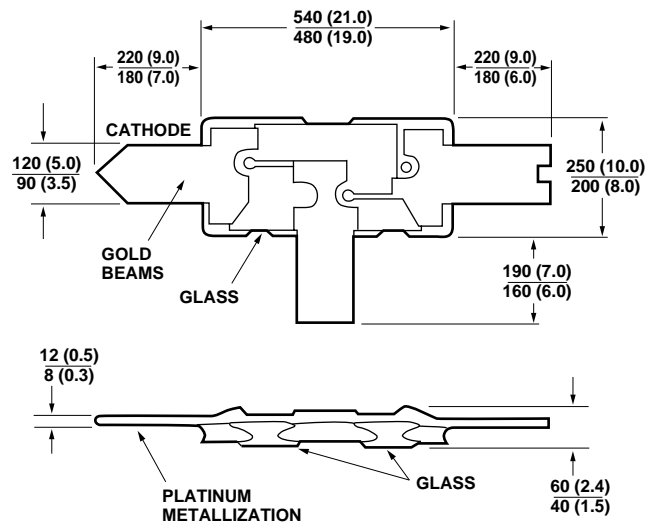

DIMENSIONS IN μm (1/1000 inch)

Maximum Ratings (for Each Diode)

- Pulse Power Incident at $T_A = 25^\circ\text{C}$ 1 W
Pulse Width = 1 μs , $D_u = 0.001$
- CW Power Dissipation at $T_A = 25^\circ\text{C}$ 150 mW
Measured in an infinite heat sink derated linearly to zero at maximum rated temperature
- T_{OPR} - Operating Temperature Range -65°C to $+175^\circ\text{C}$
- T_{STG} - Storage Temperature Range -65°C to $+200^\circ\text{C}$
- Minimum Lead Strength 4 grams pull on any lead
- Diode Mounting Temperature 350°C for 10 sec. max.

These diodes are ESD sensitive. Handle with care to avoid static discharge through the diode.

Applications

The beam lead diode is ideally suited for use in stripline or microstrip or coplanar waveguide circuits. Its small physical size and uniform dimensions give it low parasitics and repeatable RF characteristics through K-band.

These dual beam leads are intended for use in balanced mixers and in even harmonic anti-parallel pair mixers. By using several of these devices in the proper configuration it is easy to assemble bridge quads, star quads, and ring quads for Class I, II, or III type double balanced mixers.

Assembly Techniques

Thermocompression bonding is recommended. Welding or conductive epoxy may also be used. For additional information see Application Note 979, "The Handling and Bonding of Beam Lead Devices Made Easy," or Application Note 993, "Beam Lead Device Bonding to Soft Substrates."

Electrical Specifications for DC Tested Diodes at $T_A = 25^\circ\text{C}$

Part Number HSCH-[1]	Barrier	Minimum Breakdown Voltage V_{BR} (V)	Maximum Dynamic Resistance R_D (Ω)	Max. ΔR_D (Ω)	Maximum Total Capacitance C_T (pF)	Max. ΔC_T (pF)	Maximum Forward Voltage V_F (mV)	Max. ΔV_F (mV)	Max. I_R (nA)
5511	Medium	4	20	3	0.10	0.02	500	10	100
5512			16	2	0.15	0.03			
5531	Low		20	3	0.10	0.02	375	400	
Test Conditions		$I_R = 10 \mu\text{A}$	$I_F = 5 \text{ mA}$		$V_R = 0 \text{ V}$ $f = 1 \text{ MHz}$		$I_F = 1 \text{ mA}$		$V_R = 1 \text{ V}$

Note:

1. Standard Hi-Rel program available on HSCH-5511 and HSCH-5531. Others are available upon request.

Typical Detector Characteristics at $T_A = 25^\circ\text{C}$

Medium Barrier and Low Barrier (DC Bias)

Parameter	Symbol	Typical Value	Units	Test Conditions
Tangential Sensitivity	TSS	-55	dBm	20 μA Bias, Zero Bias, $P_{in} = -40 \text{ dBm}$, $R_L = 100 \text{ K}\Omega$ Video Bandwidth = 2 MHz $f = 10 \text{ GHz}$
Voltage Sensitivity	γ	9.0	mV/ μW	
Video Resistance	R_V	1350	Ω	

Low Barrier (Zero Bias)

Parameter	Symbol	Typical Value	Units	Test Conditions
Tangential Sensitivity	TSS	-46	dBm	Zero Bias, Zero Bias, $P_{in} = -30 \text{ dBm}$, $R_L = 10 \text{ M}\Omega$ Video Bandwidth = 2 MHz $f = 10 \text{ GHz}$
Voltage Sensitivity	γ	17	mV/ μW	
Video Resistance	R_V	1.4	M Ω	

SPICE Parameters

Parameter	Units	HSCH-5512	HSCH-5511	HSCH-5531
B_V	V	5	5	5
C_{J0}	pF	0.13	0.09	0.09
E_G	eV	0.69	0.69	0.69
I_{BV}	A	10E-5	10E-5	10E-5
I_S	A	3 x 10E-10	3 x 10E-10	4 x 10E-8
N		1.08	1.08	1.08
R_S	Ω	9	13	13
P_B	V	0.65	0.65	0.5
P_T		2	2	2
M		0.5	0.5	0.5

Typical Parameters

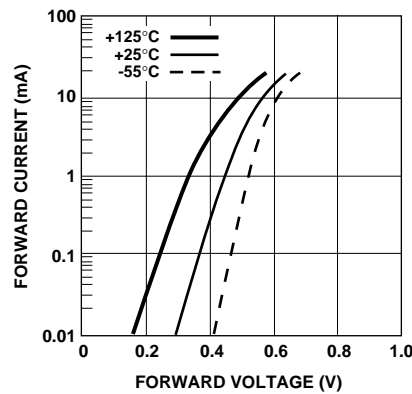

Figure 1. Typical Forward Characteristics for Medium Barrier Beam Lead Diodes. HSCH-551X Series.

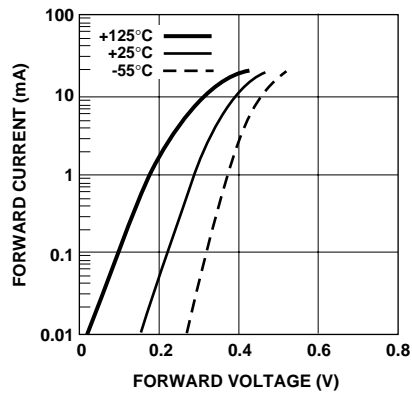

Figure 2. Typical Forward Characteristics for Low Barrier Beam Lead Diodes. HSCH-553X Series.

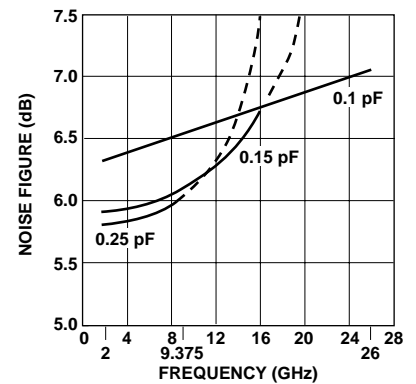

Figure 3. Typical Noise Figure vs. Frequency.

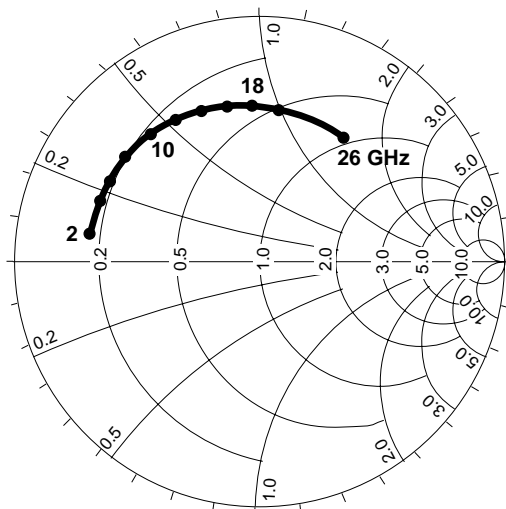

Figure 4. Typical Admittance Characteristics with 1 mA Self Bias. HSCH-5511 and -5331.

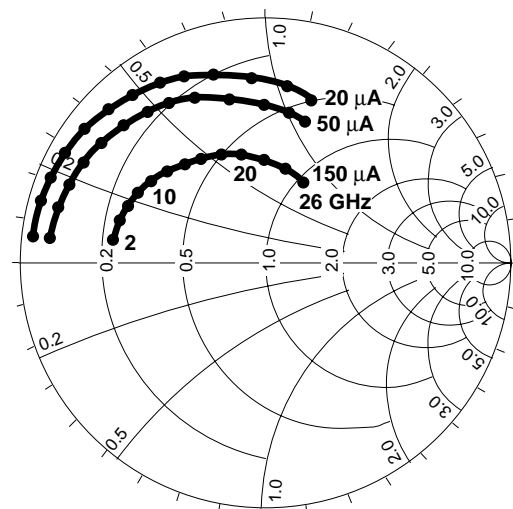

Figure 5. Typical Admittance Characteristics with External Bias. HSCH-5511 and -5331.

Typical Parameters, continued

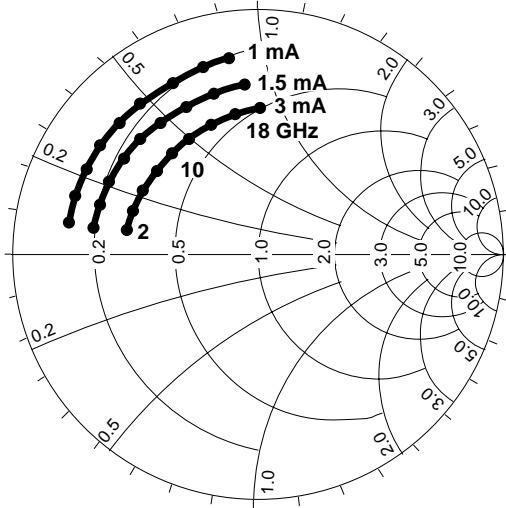

Figure 6. Typical Admittance Characteristics with Self Bias. HSCH-5512.

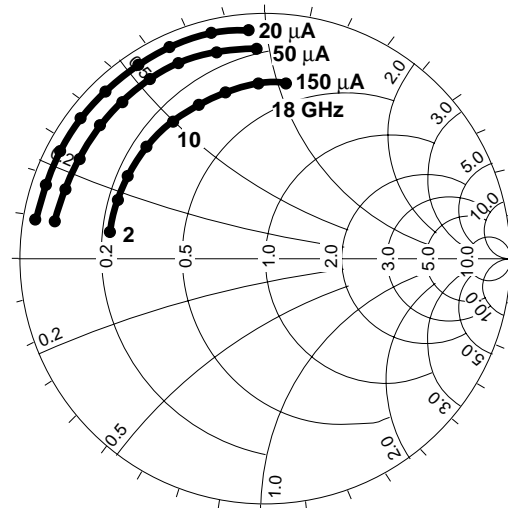

Figure 7. Typical Admittance Characteristics with External Bias. HSCH-5512.

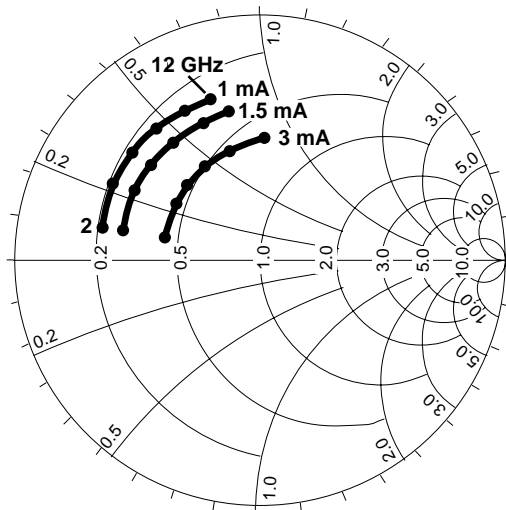

Figure 8. Typical Admittance Characteristics with Self Bias. HSCH-5536.

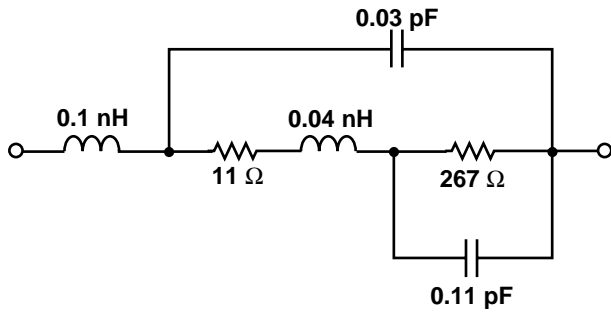

Figure 9. Typical Admittance Characteristics with External Bias. HSCH-5536.

Models for Each Beam Lead Schottky Diode

HSCH-5511, -5531

1 mA Self Bias



HSCH-5512

Self Bias

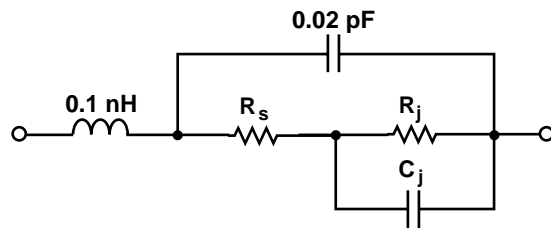

Part Number	1.0 mA Self Bias			1.5 mA Self Bias			3.0 mA Self Bias		
	R_1 (Ω)	R_2 (Ω)	C (pF)	R_1 (Ω)	R_2 (Ω)	C (pF)	R_1 (Ω)	R_2 (Ω)	C (pF)
HSCH-5512	5.0	393	0.11	5.2	232	0.11	5.0	150	0.12



Models for Each Beam Lead Schottky Diode, continued

HSCH-5511, -5531
External Bias

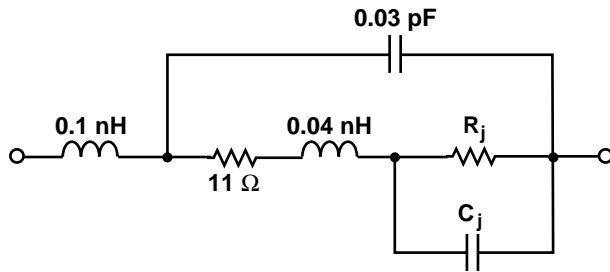

Part Numbers	20 μ A DC Bias		50 μ A DC Bias		150 μ A DC Bias	
	R_j (Ω)	C_j (pF)	R_j (Ω)	C_j (pF)	R_j (Ω)	C_j (pF)
HSCH-5511, -5531	1400	0.09	560	0.09	187	0.10

HSCH-5512
External Bias

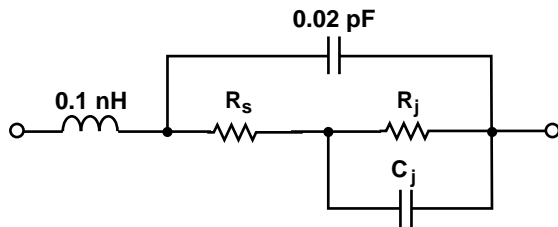

Part Numbers	20 μ A DC Bias			50 μ A DC Bias			150 μ A DC Bias		
	R_s (Ω)	R_j (Ω)	C_j (pF)	R_s (Ω)	R_j (Ω)	C_j (pF)	R_s (Ω)	R_j (Ω)	C_j (pF)
HSCH-5512	2.8	1240	0.11	4.7	550	0.12	2.7	180	0.13