

Solid Tantalum Chip Capacitors TANTAMOUNT®, Conformal Coated

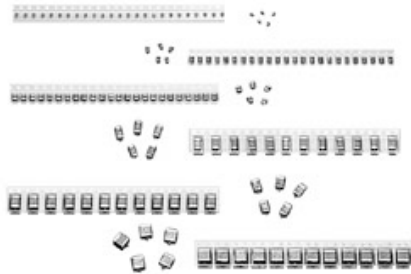

FEATURES

- Pad compatible with 194D and MIL-C-556365/4 (CWR06).
- 8mm, 12mm 16mm Tape to EIA-481-2 and reeling per IEC 286-3. 7" [178mm] standard. 13" [330mm] available.
- Terminations: Tin (2) standard.

PERFORMANCE CHARACTERISTICS

Operating Temperature: - 55°C to + 85°C. (To + 125°C with voltage derating.)

Capacitance Range: .10μF to 270μF

Capacitance Tolerance: ±10%, ±20% standard.

Voltage Rating: 4 WVDC to 50 WVDC.

ORDERING INFORMATION

695D	475	X0	004	A	2	T
TYPE	CAPACITANCE	CAPACITANCE TOLERANCE	DC VOLTAGE RATING @ + 85°C	CASE CODE	TERMINATION	PACKAGING
This is expressed in picofarads. The first two digits are the significant figures. The third is the number of zeros to follow.		X0 = ± 20% X9 = ± 10%	This is expressed in volts. To complete the three-digit block, zeros precede the voltage rating.	See Ratings and Case Codes Table.	2 = Solderable Coating. 4 = Gold Plated. 8 = Solder Plated (60/40) Special Order.	T = Tape and Reel 7" [178mm] Reel W = 13" [330mm] Reel (1/2 reel minimum) See Tape and Reel Specifications

NOTE: Preferred Tolerances and reel sizes are in bold.

We reserve the right to supply higher voltage ratings and tighter capacitance tolerance capacitors in the same case size. Voltage substitutions will be marked with the higher voltage rating.

DIMENSIONS in inches [millimeters]

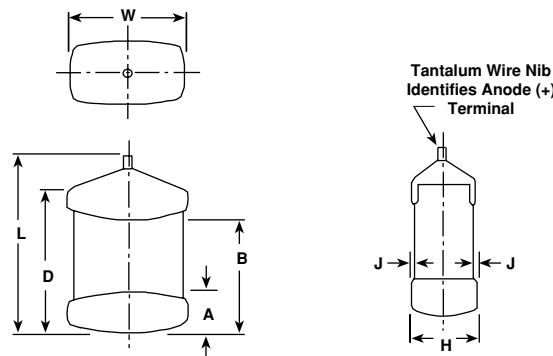

CASE CODE	L (Max.)	D (Ref.)	W	H	A	B	J (Max.)
A	0.135 [3.4]	0.100 [2.54]	0.050 ± 0.015 [1.27 ± 0.38]	0.050 ± .015 [1.27 ± 0.38]	0.023 ± 0.010 [0.584 ± 0.25]	0.067 ± 0.015 [1.70 ± 0.38]	0.004 [0.10]
B	0.185 [4.7]	0.150 [3.81]	0.050 ± 0.015 [1.27 ± 0.38]	0.050 ± 0.015 [1.27 ± 0.38]	0.040 ± 0.015 [1.02 ± 0.38]	0.120 ± 0.015 [3.05 ± 0.38]	0.004 [0.10]
D	0.185 [4.7]	0.140 [3.56]	0.095 ± 0.015 [2.41 ± 0.38]	0.050 ± 0.015 [1.27 ± 0.38]	0.040 ± 0.015 [1.02 ± 0.38]	0.110 ± 0.020 [2.79 ± 0.51]	0.004 [0.10]
E	0.235 [6.0]	0.200 [5.08]	0.095 ± 0.015 [2.41 ± 0.38]	0.050 ± 0.015 [1.27 ± 0.38]	0.040 ± 0.015 [1.02 ± 0.38]	0.170 ± 0.020 [4.32 ± 0.51]	0.004 [0.10]
F	0.255 [6.5]	0.220 [5.59]	0.135 ± 0.015 [3.43 ± 0.38]	0.070 ± 0.015 [1.78 ± 0.38]	0.040 ± 0.015 [1.02 ± 0.38]	0.185 ± 0.020 [4.70 ± 0.51]	0.004 [0.10]
G	0.300 [7.6]	0.260 [6.60]	0.100 ± 0.015 [2.54 ± 0.38]	0.100 ± 0.015 [2.54 ± 0.38]	0.040 ± 0.015 [1.02 ± 0.38]	0.220 ± 0.020 [5.59 ± 0.51]	0.004 [0.10]
H	0.303 [7.7]	0.265 [6.73]	0.150 ± 0.015 [3.81 ± 0.38]	0.110 ± 0.015 [2.79 ± 0.38]	0.050 ± 0.015 [1.27 ± 0.38]	0.220 ± 0.020 [5.59 ± 0.51]	0.004 [0.10]

Note: The anode termination (D less B) will be a minimum of 0.010" [0.3mm]. T Case = 0.005" [0.13mm] minimum.



RATINGS AND CASE CODES								
μF	4 V	6 V	10 V	15 V	20 V	25 V	35 V	50 V
0.10								A
0.15								A
0.22							A	B
0.33							A	B
0.47						A	B	D
0.68						A	B	D
1.0					A	B	D	D
1.5				A	B	D	D	E
2.2				A	B	D	E	F
3.3			A	B	D	D	F	F
4.7	A	A	B	D	D	E	F	G
6.8	B	B	D	D	E	F	F	H
10	B	D	D	D	F	F	G	H
15	D	D	D	E	F	G	H	
22	D	D	E	F	G	H		
33	E	E	F	F	G	H		
47	F	F	F	G	H			
68	F	F	G	H				
100	F	G	G	H				
120	G	G	H					
150	G	H	H					
180	H	H						
220	H	H						
270	H							

STANDARD RATINGS							
CAPACITANCE (μF)	CASE CODE	PART NUMBER*	Max. DCL @ + 25°C (μA)	Max. DF @ + 25°C 120 Hz (%)	Max. ESR @ + 25°C 100kHz (Ohms)	Max. RIPPLE 100kHz I _{rms} (Amps)	
4 WVDC @ + 85°C, SURGE = 5.2 V . . . 2.7 WVDC @ + 125°C, SURGE = 3.4 V							
4.7	A	695D475X_004A2T	0.5	6	11	0.07	
6.8	B	695D685X_004B2T	0.5	6	9	0.09	
10	B	695D106X_004B2T	0.5	6	8.5	0.09	
15	D	695D156X_004D2T	0.6	6	2.2	0.20	
22	D	695D226X_004D2T	0.9	6	2	0.21	
33	E	695D336X_004E2T	1.3	6	1.5	0.25	
47	F	695D476X_004F2T	1.9	6	1	0.33	
68	F	695D686X_004F2T	2.7	6	0.9	0.35	
100	F	695D107X_004F2T	4.0	8	0.9	0.35	
120	G	695D127X_004G2T	4.8	8	0.7	0.41	
150	G	695D157X_004G2T	6.0	8	0.65	0.43	
180	H	695D187X_004H2T	7.2	8	0.4	0.61	
220	H	695D227X_004H2T	8.8	8	0.35	0.65	
270	H	695D277X_004H2T	10.8	8	0.35	0.65	
6 WVDC @ + 85°C, SURGE = 8 V . . . 4 WVDC @ + 125°C, SURGE = 5 V							
4.7	A	695D475X_006A2T	0.5	6	11	0.07	
6.8	B	695D685X_006B2T	0.5	6	9	0.07	

For 10% tolerance, specify "9"; for 20% tolerance, change to "0".



STANDARD RATINGS						
CAPACITANCE (μ F)	CASE CODE	PART NUMBER*	Max. DCL @ + 25°C (μ A)	Max. DF @ + 25°C 120 Hz (%)	Max. ESR @ + 25°C 100kHz (Ohms)	Max. RIPPLE 100kHz I _{rms} (Amps)
6 WVDC @ + 85°C, SURGE = 8 V . . . 4 WVDC @ + 125°C, SURGE = 5 V						
10	D	695D106X_006D2T	0.6	6	8.5	0.1
15	D	695D156X_006D2T	0.9	6	2.2	0.2
22	D	695D226X_006D2T	1.3	6	2	0.32
33	E	695D336X_006E2T	2.0	6	1.5	0.25
47	F	695D476X_006F2T	2.8	6	1	0.33
68	F	695D686X_006F2T	4.1	6	0.9	0.35
100	G	695D107X_006G2T	6.0	8	0.9	0.37
120	G	695D127X_006G2T	7.2	8	0.7	0.41
150	H	695D157X_006H2T	9.0	8	0.65	0.48
180	H	695D187X_006H2T	10.8	8	0.4	0.61
220	H	695D227X_006H2T	13.2	8	0.35	0.65
10 WVDC @ + 85°C, SURGE = 13 V . . . 7 WVDC @ + 125°C, SURGE = 8 V						
3.3	A	695D335X_010A2T	0.5	6	11.5	0.07
4.7	B	695D475X_010B2T	0.5	6	10.6	0.08
6.8	D	695D685X_010D2T	0.7	6	2.6	0.18
10	D	695D106X_010D2T	1.0	6	2.5	0.18
15	D	695D156X_010D2T	1.5	6	2.2	0.20
22	E	695D226X_010E2T	2.2	6	2	0.22
33	F	695D336X_010F2T	3.3	6	1.2	0.30
47	F	695D476X_010F2T	4.7	6	1	0.33
68	G	695D686X_010G2T	6.8	6	0.75	0.40
100	G	695D107X_010G2T	10	8	0.75	0.40
120	H	695D127X_010H2T	12	8	0.45	0.58
150	H	695D157X_010H2T	15	8	0.40	0.61
15 WVDC @ + 85°C, SURGE = 20 V . . . 10 WVDC @ + 125°C, SURGE = 12 V						
1.5	A	695D155X_015A2T	0.5	6	14	0.07
2.2	A	695D225X_015A2T	0.5	6	12	0.07
3.3	B	695D335X_015B2T	0.5	6	10.8	0.08
4.7	D	695D475X_015D2T	0.7	6	2.8	0.17
6.8	D	695D685X_015D2T	1	6	2.6	0.18
10	D	695D106X_015D2T	1.5	6	2.5	0.18
15	E	695D156X_015E2T	2.3	6	2.3	0.20
22	F	695D226X_015F2T	3.3	6	1.4	0.28
33	F	695D336X_015F2T	5	6	1.2	0.30
47	G	695D476X_015G2T	7.1	6	0.8	0.39
68	H	695D686X_015H2T	10.2	6	0.5	0.55
100	H	695D107X_015H2T	15	8	0.45	0.58
20 WVDC @ + 85°C, SURGE = 26 V . . . 13 WVDC @ + 125°C, SURGE = 16 V						
1.0	A	695D105X_020A2T	0.5	4	15	0.06
1.5	B	695D155X_020B2T	0.5	6	12	0.08
2.2	B	695D225X_020B2T	0.5	6	11	0.08
3.3	D	695D335X_020D2T	0.7	6	3	0.17

For 10% tolerance, specify "9"; for 20% tolerance, change to "0".



STANDARD RATINGS						
CAPACITANCE (μ F)	CASE CODE	PART NUMBER*	Max. DCL @ + 25°C (μ A)	Max. DF @ + 25°C 120 Hz (%)	Max. ESR @ + 25°C 100kHz (Ohms)	Max. RIPPLE 100kHz Irms (Amps)
20 WVDC @ + 85°C, SURGE = 26 V ... 13 WVDC @ + 125°C, SURGE = 16 V						
4.7	D	695D475X_020D2T	0.9	6	2.8	0.17
6.8	E	695D685X_020E2T	1.4	6	2.55	0.19
10	F	695D106X_020F2T	2.0	6	1.8	0.25
15	F	695D156X_020F2T	3.0	6	1.5	0.27
22	G	695D226X_020G2T	4.4	6	0.9	0.37
33	G	695D336X_020G2T	6.6	6	0.8	0.39
47	H	695D476X_020H2T	9.4	6	0.5	0.55
25 WVDC @ + 85°C, SURGE = 32 V ... 17 WVDC @ + 125°C, SURGE = 20 V						
0.47	A	695D474X_025A2T	0.5	4	17	0.06
0.68	A	695D684X_025A2T	0.5	4	15	0.06
1.0	B	695D105X_025B2T	0.5	4	13	0.08
1.5	D	695D155X_025D2T	0.5	6	4.2	0.14
2.2	D	695D225X_025D2T	0.6	6	3.5	0.16
3.3	D	695D335X_025D2T	0.8	6	3	0.17
4.7	E	695D475X_025E2T	1.2	6	2.75	0.19
6.8	F	695D685X_025F2T	1.7	6	2	0.23
10	F	695D106X_025F2T	2.5	6	1.8	0.25
15	G	695D156X_025G2T	3.8	6	1	0.35
22	H	695D226X_025H2T	5.5	6	0.7	0.46
33	H	695D336X_025H2T	8.3	6	0.8	0.50
35 WVDC @ + 85°C, SURGE = 46 V ... 23 WVDC @ + 125°C, SURGE = 28 V						
0.22	A	695D224X_035A2T	0.5	4	20	0.05
0.33	A	695D334X_035A2T	0.5	4	18	0.06
0.47	B	695D474X_035B2T	0.5	4	15	0.07
0.68	B	695D684X_035B2T	0.5	4	14	0.07
1.0	D	695D105X_035D2T	0.5	4	8	0.10
1.5	D	695D155X_035D2T	0.5	6	4.2	0.14
2.2	E	695D225X_035E2T	0.8	6	4	0.15
3.3	F	695D335X_035F2T	1.2	6	3.2	0.19
4.7	F	695D475X_035F2T	1.6	6	2.7	0.20
6.8	F	695D685X_035F2T	2.4	6	2	0.23
10	G	695D106X_035G2T	3.5	6	1.3	0.30
15	H	695D156X_035H2T	5.3	6	0.8	0.43
50 WVDC @ + 85°C, SURGE = 65 V ... 33 WVDC @ + 125°C, SURGE = 38 V						
0.10	A	695D104X_050A2T	0.5	4	32	0.04
0.15	A	695D154X_050A2T	0.5	4	30	0.04
0.22	B	695D224X_050B2T	0.5	4	18	0.06
0.33	B	695D334X_050B2T	0.5	4	16	0.07
0.47	D	695D474X_050D2T	0.5	4	9	0.10
0.68	D	695D684X_050D2T	0.5	4	8.5	0.10
1.0	D	695D105X_050D2T	0.5	4	8	0.10
1.5	E	695D155X_050E2T	0.8	6	5.5	0.13
2.2	F	695D225X_050F2T	1.1	6	3.9	0.17
3.3	F	695D335X_050F2T	1.7	6	3.2	0.19
4.7	G	695D475X_050G2T	2.4	6	2.5	0.22
6.8	H	695D685X_050H2T	3.4	6	1.2	0.35
10	H	695D106X_050H2T	5.0	6	1	0.39

*Preliminary values, contact factory for availability. For 10% tolerance, specify "9"; for 20% tolerance, change to "0".



TYPICAL CURVES @ + 25°C, IMPEDANCE AND ESR VS FREQUENCY

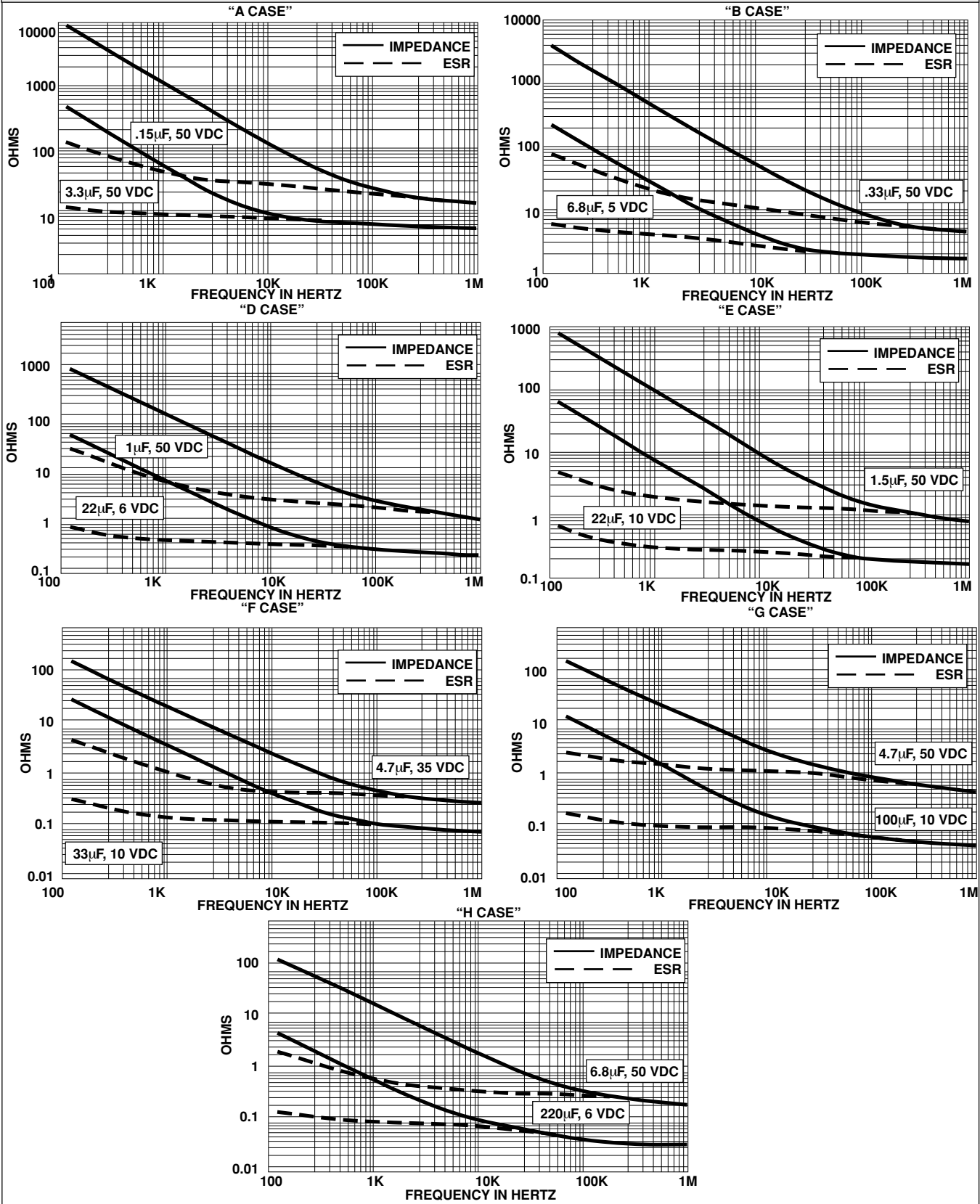

PERFORMANCE CHARACTERISTICS

1. **Operating Temperature:** Capacitors are designed to operate over the temperature range - 55°C to + 85°C.

1.1 Capacitors may be operated to + 125°C with voltage derating to two-thirds the + 85°C rating.

+ 85°C Rating		+ 125°C Rating	
Working Voltage (V)	Surge Voltage (V)	Working Voltage (V)	Surge Voltage (V)
4	5.2	2.7	3.4
6	8	4	5
10	13	7	8
15	20	10	12
20	26	13	16
25	32	17	20
35	46	23	28
50	65	33	38

2. **DC Working Voltage:** The DC working voltage is the maximum operating voltage for continuous duty at the rated temperature.

3. **Surge Voltage:** The surge DC rating is the maximum voltage to which the capacitors may be subjected under any conditions, including transients and peak ripple at the highest line voltage.

3.1 **Surge Voltage Test:** Capacitors shall withstand the surge voltage applied in series with a 33 ohm ± 5% resistor at the rate of one-half minute on, one-half minute off, at + 85°C, for 1000 successive test cycles.

3.2 Following the surge voltage test, the dissipation factor and the leakage current shall meet the initial requirements; the capacitance shall not have changed more than ± 10%.

4. **Capacitance Tolerance:** The capacitance of all capacitors shall be within the specified tolerance limits of the normal rating.

4.1 Capacitance measurements shall be made by means of polarized capacitance bridge. The polarizing voltage shall be of such magnitude that there shall be no reversal of polarity due to the AC component. The maximum voltage applied to capacitors during measurement shall be 2 volts rms at 120 Hz at +25°C. If the AC voltage applied is less than one-half volt rms, no DC bias is required. Accuracy of the bridge shall be within ± 2%.

5. **Capacitance Change With Temperature:** The capacitance change with temperature shall not exceed the following percentage of the capacitance measured at + 25°C:

- 55°C	+ 85°C	+ 125°C
- 10%	+ 10%	+ 12%

6. **Dissipation Factor:** The dissipation factor, determined from the expression $2\pi fRC$, shall not exceed values listed in the Standard Ratings Table.

6.1 Measurements shall be made by the bridge method at, or referred to, a frequency of 120 Hz and a temperature of + 25°C.

7. **Leakage Current:** Capacitors shall be stabilized at the rated temperature for 30 minutes. Rated voltage shall be applied to capacitors for 5 minutes using a steady source of power (such as a regulated power supply) with 1000 ohm resistor connected in series with the capacitor under test to limit the charging current. Leakage current shall then be measured.

Note that the leakage current varies with temperature and applied voltage. See graph below for the appropriate adjustment factor.

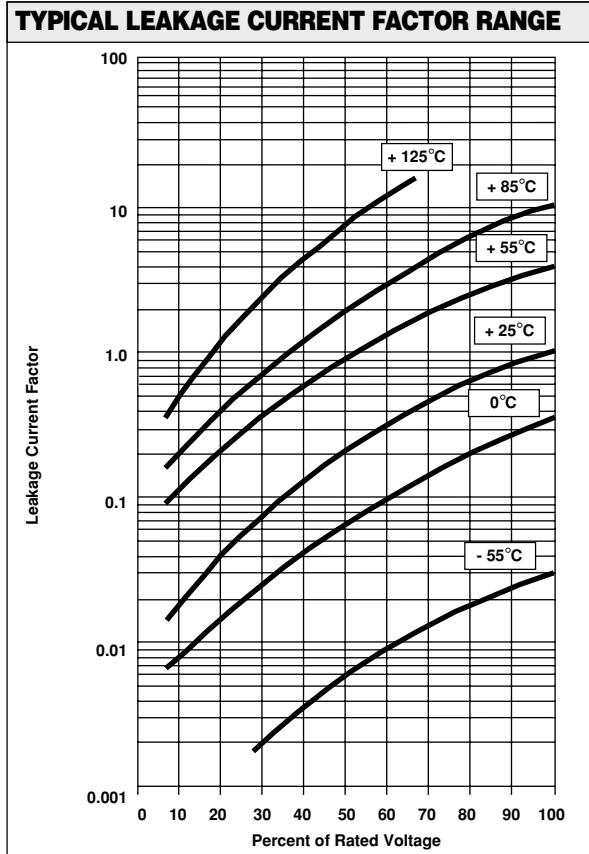

PERFORMANCE CHARACTERISTICS (Continued)

- 8 Life Test:** Capacitors shall be able to withstand rated DC voltage applied at +85°C for 2000 hours or derated DC voltage applied at +125°C for 1000 hours.
- 8.1** Following the life test, the capacitance change shall not exceed ±10% of the initial value; the dissipation factor and leakage current shall meet the initial requirement.
- 9 Humidity Test:** Capacitors shall withstand 1000 hours at +40°C, 90% to 95% relative humidity, with no voltage applied.
- 9.1** Following the humidity test, capacitance change shall be within 10% of the initial value; the dissipation factor shall not exceed 150% of the initial requirement; the leakage current shall not exceed 200% of the initial requirement at +25°C.
- 10 Soldering Testing:** Capacitors shall be checked by the following method: Terminations are immersed in non-activated flux and dipped in 60/40 Sn/Pb solder for 5 seconds at +245°C. Wetting must occur on at least 95% of the external surface of the terminations.
- 11 Resistance to Soldering Heat:** Capacitors mounted on a substrate will withstand exposure to +260°C for 5 seconds.
- 11.1** Following the resistance to soldering heat test, capacitance shall be within initial tolerance; dissipation factor shall be within 120% of initial requirement at +25°C; the leakage current shall be within initial requirement at +25°C.
- 12 Marking:** The small body area of the capacitor does not allow elaborate marking schemes. All required information is present on the carton or package in which the parts are shipped; in addition, part number, quantity and date code are indicated on the reels.

GUIDE TO APPLICATION

- 1. A-C Ripple Current:** The maximum allowable ripple current shall be determined from the formula:

$$I_{rms} = \sqrt{\frac{P}{R_{ESR}}}$$

where,

P = Power Dissipation in Watts @ + 25°C as given in the table in Paragraph Number 5 (Power Dissipation).

R_{ESR} = The capacitor Equivalent Series Resistance at the specified frequency.

- 2. A-C Ripple Voltage:** The maximum allowable ripple voltage shall be determined from the formula:

$$V_{rms} = Z \sqrt{\frac{P}{R_{ESR}}}$$

R_{ESR} = The capacitor Equivalent Series Resistance at the specified frequency.

Z = The capacitor Impedance at the specified frequency.

- 2.1** The sum of the peak AC voltage plus the DC voltage shall not exceed the DC voltage rating of the capacitor.
- 2.2** The sum of the negative peak AC voltage plus the applied DC voltage shall not allow a voltage reversal exceeding 10% of the DC working voltage at + 25°C.
- 3. Reverse Voltage:** These capacitors are capable of withstanding peak voltages in the reverse direction equal to 10% of the DC rating at + 25°C and 5% of the DC rating at + 85°C and 1% of the DC rating at +85°C and 1% of the DC rating at +125°C.
- 4. Temperature Derating:** If these capacitors are to be operated at temperatures above + 25°C, the permissible rms ripple current or voltage shall be calculated using the derating factors as shown:

Temperature	Derating Factor
+ 25°C	1.0
+ 55°C	0.9
+ 85°C	0.8
+ 125°C	0.4

GUIDE TO APPLICATION (Continued)

5. Power Dissipation: Power dissipation will be affected by the heat sinking capability of the mounting surface. Non-sinusoidal ripple current may produce heating effects which differ from those shown. It is important that the equivalent *I_{rms}* value be established when calculating permissible operating levels. (Power dissipation calculated using + 25°C temperature rise.)

Case Code	Maximum Permissible Power Dissipation @ + 25°C (Watts) in free air
A	0.060
B	0.075
D	0.085
E	0.095
F	0.110
G	0.120
H	0.150

6. Printed Circuit Board Materials: The 695D is compatible with most commonly used printed circuit board materials (alumina substrates, FR4, FR5, G10, PTFE-fluorocarbon and porcelainized steel). If your desired board material is not shown there, please contact the Tantalum Marketing Department for assistance in determining compatibility.

7. Attachment:

7.1 Solder Paste: The recommended thickness of the solder paste after application is .007" ± .001" [1.78mm ± .025mm]. Care should be exercised in selecting the solder paste. The metal purity should be as high as practical. The flux (in the paste) must be active enough to remove the oxides formed on the metallization prior to the exposure to soldering heat. In practice this can be aided by extending the solder preheat time at temperatures below the liquidous state of the solder.

7.2 Soldering: Capacitors can be attached by conventional soldering techniques - convection, infrared reflow, wave soldering and hot plate methods. The Solder Temperature/Soldering Time

chart shows maximum recommended time/temperature conditions for soldering. Attachment with a soldering iron is not recommended due to the difficulty of controlling time at temperature.

8. Cleaning (Flux Removal) After Soldering: The 695D is compatible with all commonly used solvents such as TES, TMS, Prelete, Chloroethane.

Solvents containing methylene chloride or other epoxy solvents should be avoided since these will attack the epoxy encapsulation material.

9. Recommended Mounting Pad Geometries: The area under the tantalum wire nib should not be metalised on the PC board. The nib must have sufficient clearance to avoid electrical contact with other components. The width dimension indicated is the same as the maximum width of the capacitor. This is to minimize lateral movement.

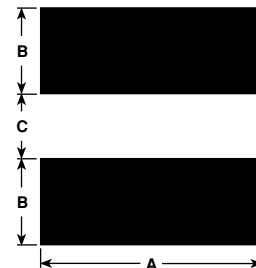
REFLOW SOLDER PADS* in inches [millimeters]

* Pads for B, C and D case codes are otherwise pad compatible with Type 293D, B, C and D case codes respectively.

CASE CODE	WIDTH (A)	PAD METALLIZATION (B)	SEPARATION (C)
A	0.065 [1.6]	0.050 [1.3]	0.040 [1.0]
B	0.065 [1.6]	0.070 [1.8]	0.055 [1.4]
D	0.115 [2.9]	0.070 [1.8]	0.070 [1.8]
E	0.115 [2.9]	0.070 [1.8]	0.120 [3.0]
F	0.150 [3.8]	0.070 [1.8]	0.140 [3.6]
G	0.115 [2.9]	0.070 [1.8]	0.170 [4.3]
H	0.165 [4.2]	0.090 [2.3]	0.170 [4.3]

RECOMMENDED REFLOW SOLDERING PROFILE

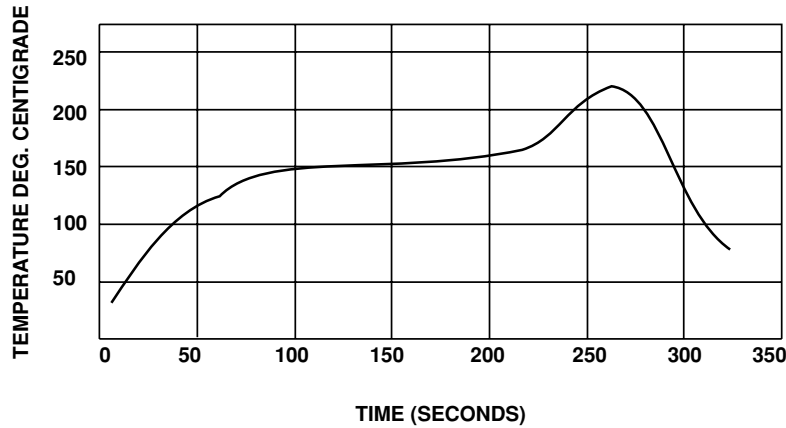

TAPE AND REEL PACKAGING in inches [millimeters]

Tape and Reel Specifications: All case codes are available on plastic embossed tape per EIA-481-2. Tape reeling per IEC 286-3 is also available. Standard reel diameter is 7" [178]. 13" [330] reels are available and recommended as the most cost effective packaging method.

The most efficient packaging quantities are full reel increments on given reel diameter. The quantities shown allow for the sealed empty pockets required to be in conformance with EIA-481-1 and EIA-481-2. Reel size and packaging orientation must be specified in the Vishay Sprague part number.

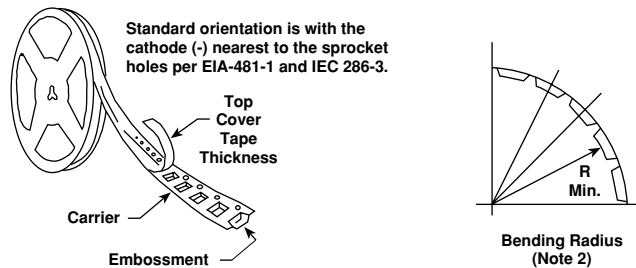

Case Code	Tape Width	Component Pitch	Units Per Reel	
			7" [178] Reel	13" [330] Reel
A	8mm	4mm	2500	10,000
B	12mm	4mm	2500	10,000
D	12mm	4mm	2500	10,000
E	12mm	4mm	2500	10,000
F	12mm	8mm	1000	4000
G	12mm	4mm	1500	5000
H	16mm	8mm	600	2500

TAPE AND REEL PACKAGING lin inches [millimeters]

Note: Metric dimensions will govern. Dimensions in inches are rounded and for reference only.

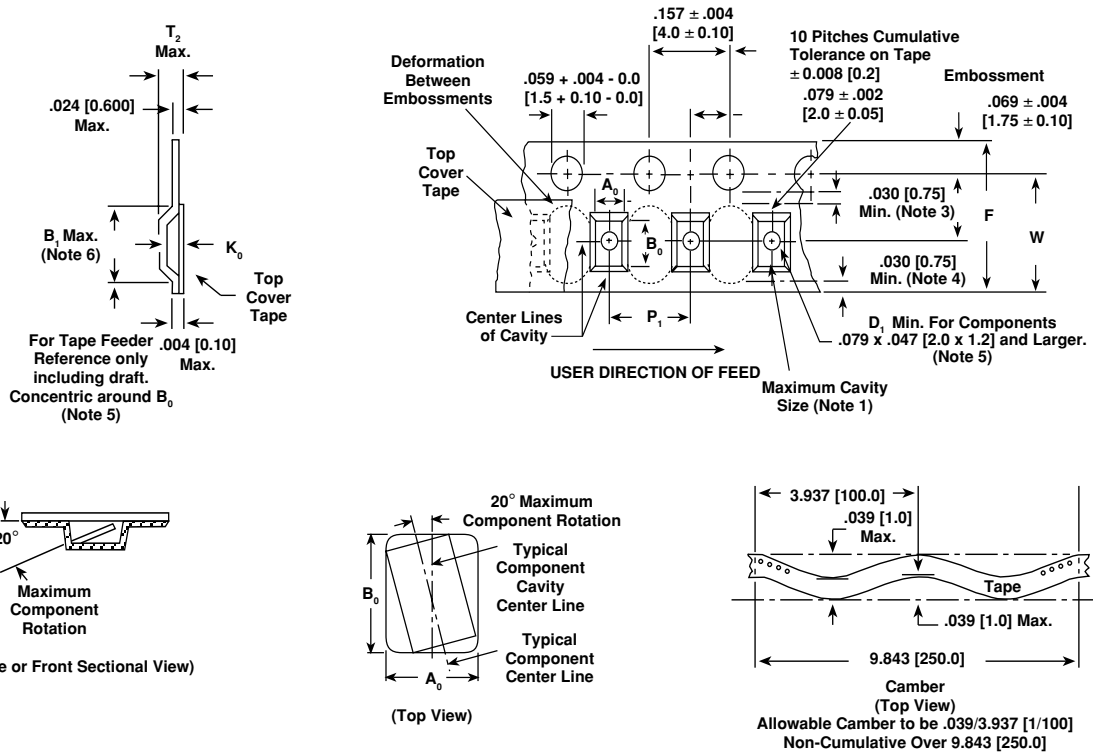

TAPE SIZE	B ₁ (Max.) (Note 5)	D ₁ (Min.) (Note 4)	E (Min.)	F	P ₁	P ₂	S ₁ (Min.)	T ₂ (Max.)	W	A ₀ B ₀ K ₀
8mm	0.179 [4.55]	0.039 [1.0]	-	0.138 ± 0.002 [3.5 ± 0.05]	0.157 ± 0.004 [4.0 ± 0.1]	0.079 ± 0.002 [2.0 ± 0.05]	-	0.098 [2.5]	0.315 + 0.012 - 0.004 [8.0 + 0.3 - 0.1]	(Note 1)
12mm	0.323 [8.2]	0.059 [1.5]	-	0.217 ± 0.002 [5.5 ± 0.05]	0.157 ± 0.004 [4.0 ± 0.1]	0.079 ± 0.002 [2.0 ± 0.05]	-	0.256 [6.5]	0.472 ± 0.012 [12.0 ± 0.30]	
12mm Double Pitch	0.323 [8.2]	0.059 [1.5]	-	0.217 ± 0.002 [5.5 ± 0.05]	0.315 ± 0.004 [8.0 ± 0.1]	0.079 ± 0.002 [2.0 ± 0.05]	-	0.256 [6.5]	0.472 ± 0.012 [12.0 ± 0.30]	
18mm	0.476 [12.1]	0.059 [1.5]	0.561 [14.25]	0.295 ± 0.004 [7.5 ± 0.1]	0.315 ± 0.004 [8.0 ± 0.1]	0.79 ± 0.004 [2.0 ± 0.1]	0.024 [0.6]	0.315 [8.0]	0.642 Max. [16.3] Max.	

Notes:

- A₀B₀K₀ are determined by the maximum dimensions to the ends of the terminals extending from the component body and/or the body dimensions of the component. The clearance between the ends of the terminals or body of the component to the sides and depth of the cavity (A₀B₀K₀) must be within 0.002" [0.05mm] minimum and 0.020" [0.50mm] maximum. The clearance allowed must also prevent rotation of the component within the cavity of not more than 20 degrees for 8mm and 12mm tape. For 16mm tape the clearance must be within 0.006" [0.15] minimum and 0.035" [0.9] maximum and the clearance must also prevent rotation of the component within the cavity of not more than 10 degrees.
- This dimension is the flat area from the edge of the sprocket hole to either the outward deformation of the carrier tape between the embossed cavities or to the edge of the cavity whichever is less. Applies for 8mm and 12mm only.
- This dimension is the flat area from the edge of the carrier tape opposite the sprocket holes to either the outward deformation of the carrier tape between the embossed cavity or to the edge of the cavity whichever is less. Applies for 8mm and 12mm only.
- The embossment hole location shall be measured from the sprocket hole controlling the location of the embossment. Dimensions of embossment location and hole location shall be applied independent of each other.
- B₁ dimension is a reference dimension for tape feeder clearance only.